

Dell™ Serial-Attached SCSI 5/iR Integrated and Adapter User's Guide

Model UCS-51

Dell™ Serial-Attached SCSI 5/iR
Integrated and Adapter
User's Guide

Notes, Notices, and Cautions



NOTE: A NOTE indicates important information that helps you make better use of your computer.



NOTICE: A NOTICE indicates either potential damage to hardware or loss of data and tells you how to avoid the problem.



CAUTION: A CAUTION indicates a potential for property damage, personal injury, or death.

Information in this document is subject to change without notice.

© 2005–2007 Dell Inc. All rights reserved.

Reproduction in any manner whatsoever without the written permission of Dell Inc. is strictly forbidden.

Trademarks used in this text: *Dell*, the *DELL* logo, *Dell Precision*, *PowerEdge*, and *OpenManage* are trademarks of Dell Inc.; *Intel* is a registered trademark of Intel Corporation; *Microsoft*, *Windows*, and *Windows Server* are registered trademarks, and *Windows Vista* is trademark of Microsoft Corporation; *Novell NetWare*, and *SUSE* are registered trademarks of Novell, Inc. in the United States and other countries; *Red Hat* and *Red Hat Enterprise Linux* are registered trademarks of Red Hat, Inc.; *LSI Logic*, *Fusion-MPT*, *Integrated Mirroring*, and *Integrated Striping* are trademarks or registered trademarks of LSI Logic Corporation; *DR-DOS* is a registered trademark of DRDOS, Inc.

Other trademarks and trade names may be used in this document to refer to either the entities claiming the marks and names or their products. Dell Inc. disclaims any proprietary interest in trademarks and trade names other than its own.

Model UCS-51

January 2007 P/N YD912 Rev. A01

Contents

	CAUTION: Safety Instructions	7
	SAFETY: General	7
	SAFETY: When Working Inside Your System	7
	SAFETY: Protecting Against Electrostatic Discharge	8
1	Overview	9
	About RAID	10
	RAID Levels	10
	RAID Terminology	10
	Integrated Striping	10
	Integrated Mirroring	11
2	SAS 5/iR Features	13
3	Hardware Installation	15
	Installing the SAS 5/iR Adapter	15
4	Driver Installation	19
	Creating a Driver Diskette	19
	Installing the Driver During Windows Operating System Installation	20
	Installing a Windows Driver for a New SAS 5/iR Controller	20
	Updating an Existing Windows Driver	21
	Installing From the Dell Operating System Media	22

	Installing the Red Hat Enterprise Linux Driver	22
	Creating a Driver Diskette	22
	Installing the Driver	23
	Installing the Driver Using an Update RPM.	24
	Installing the SUSE Linux Enterprise Server Driver	24
	Installing the Driver Using an Update RPM.	24
	Installing SUSE Linux Enterprise Server Using the Driver Update Diskette	25
	Upgrading the Kernel	26
5	SAS 5/iR BIOS	27
	POST Messages	27
	BIOS Fault Code Messages.	27
	Configuration Utility	28
	Starting the Configuration Utility	28
	Functions Performed	28
	Navigating the Configuration Utility	28
	Integrated RAID Configuration and Management Screens	29
	Select New Virtual Disk Type.	29
	Create New Virtual Disk	29
	View Virtual Disk	30
	Manage Virtual Disk	30
	Exit Screen	31
	Performing Configuration Tasks	31
	Creating an Integrated Striping Virtual Disk	31
	Creating a Integrated Mirroring Virtual Disk	32
	Viewing Virtual Disk Properties.	33
	Synchronizing a Virtual Disk	33
	Activating a Virtual Disk	34
	Deleting a Virtual Disk	34
	Replacing and Rebuilding a Degraded Virtual Disk	34

6	Troubleshooting	35
	BIOS Boot Order	35
	General Problems	35
	Physical Disk Related Issues	36
	Configuration Utility Error Messages	37
	BIOS Error Messages	38
A	Updating the Firmware.	41
	Firmware Update Utility	41
B	Getting Help	43
	Obtaining Assistance	43
	Technical Support and Customer Service	43
	Online Services	44
	Automated Order-Status Service	44
	Dell Enterprise Training	45
	Problems With Your Order	45
	Product Information	45
	Returning Items for Warranty Repair or Credit	45
	Before You Call	46
C	Regulatory Notices	47
	FCC Notices (U.S. Only)	48
	FCC, Class B	48
	Industry Canada (Canada Only)	49
	Industry Canada, Class B	49

CE Notice (European Union)	49
European Union, Class B	49
Corporate Contact Details (Taiwan Only)	55
Glossary	59
Index	65

CAUTION: Safety Instructions

Use the following safety guidelines to help ensure your own personal safety and to help protect your system and working environment from potential damage.

 **NOTE:** See the safety and caution statements in your *Product Information Guide* that came with your Dell™ PowerEdge™ system or Dell Precision™ workstation.

SAFETY: General

- Observe and follow service markings. Do not service any product except as explained in your user documentation. Opening or removing covers that are marked with the triangular symbol with a lightning bolt may expose you to electrical shock. Components inside these compartments should be serviced only by a trained service technician.
- If any of the following conditions occur, unplug the product from the electrical outlet and replace the part or contact your trained service provider:
 - The power cable, extension cable, or plug is damaged.
 - An object has fallen into the product.
 - The product has been exposed to water.
 - The product has been dropped or damaged.
 - The product does not operate correctly when you follow the operating instructions.
- Use the product only with approved equipment.
- Operate the product only from the type of external power source indicated on the electrical ratings label. If you are not sure of the type of power source required, consult your service provider or local power company.
- Handle batteries carefully. Do not disassemble, crush, puncture, short external contacts, dispose of in fire or water, or expose batteries to temperatures higher than 60 degrees Celsius (140 degrees Fahrenheit). Do not attempt to open or service batteries; replace batteries only with batteries designated for the product.

SAFETY: When Working Inside Your System

Before you remove the system covers, perform the following steps in the sequence indicated.

 **CAUTION:** Except as expressly otherwise instructed in Dell documentation, only trained service technicians are authorized to remove the system cover and access any of the components inside the system.

 **NOTICE:** To help avoid possible damage to the system board, wait 5 seconds after turning off the system before removing a component from the system board or disconnecting a peripheral device.

- 1 Turn off the system and any devices.
- 2 Ground yourself by touching an unpainted metal surface on the chassis before touching anything inside the system.
- 3 While you work, periodically touch an unpainted metal surface on the chassis to dissipate any static electricity that might harm internal components.
- 4 Disconnect your system and devices from their power sources. To reduce the potential of personal injury or shock, disconnect any telecommunication lines from the system.

In addition, take note of these safety guidelines when appropriate:

- When you disconnect a cable, pull on its connector or on its strain-relief loop, not on the cable itself. Some cables have a connector with locking tabs; if you are disconnecting this type of cable, press in on the locking tabs before disconnecting the cable. As you pull connectors apart, keep them evenly aligned to avoid bending any connector pins. Also, before you connect a cable, make sure that both connectors are correctly oriented and aligned.
- Handle components and cards with care. Do not touch the components or contacts on a card. Hold a card by its edges or by its metal mounting bracket. Hold a component such as a microprocessor chip by its edges, not by its pins.

SAFETY: Protecting Against Electrostatic Discharge

Electrostatic discharge (ESD) events can harm electronic components inside your computer. Under certain conditions, ESD may build up on your body or an object, such as a peripheral, and then discharge into another object, such as your computer. To prevent ESD damage, you should discharge static electricity from your body before you interact with any of your computer's internal electronic components, such as a memory module. You can protect against ESD by touching a metal grounded object (such as an unpainted metal surface on your computer's I/O panel) before you interact with anything electronic. When connecting a peripheral (including handheld digital assistants) to your computer, you should always ground both yourself and the peripheral before connecting it to the computer. In addition, as you work inside the computer, periodically touch an I/O connector to remove any static charge your body may have accumulated.

You can also take the following steps to prevent damage from electrostatic discharge:

- When unpacking a static-sensitive component from its shipping carton, do not remove the component from the antistatic packing material until you are ready to install the component. Just before unwrapping the antistatic package, be sure to discharge static electricity from your body.
- When transporting a sensitive component, first place it in an antistatic container or packaging.
- Handle all electrostatic sensitive components in a static-safe area. If possible, use antistatic floor pads and work bench pads.

Overview

The Dell™ Serial-Attached SCSI (SAS) 5/iR controller is Dell's next generation of controller with integrated redundant array of independent disks (RAID) capabilities. SAS technology is not backward compatible with the previous generation of SCSI devices. The SAS 5/iR Adapter is a half-length, standard-height PCI-E card, while the SAS 5/iR Integrated is embedded in the platform hardware. The SAS 5/iR Adapter is supported on platforms with PCI-E x8 or x16 connectors.

Figure 1-1. SAS 5/iR Adapter Hardware Architecture

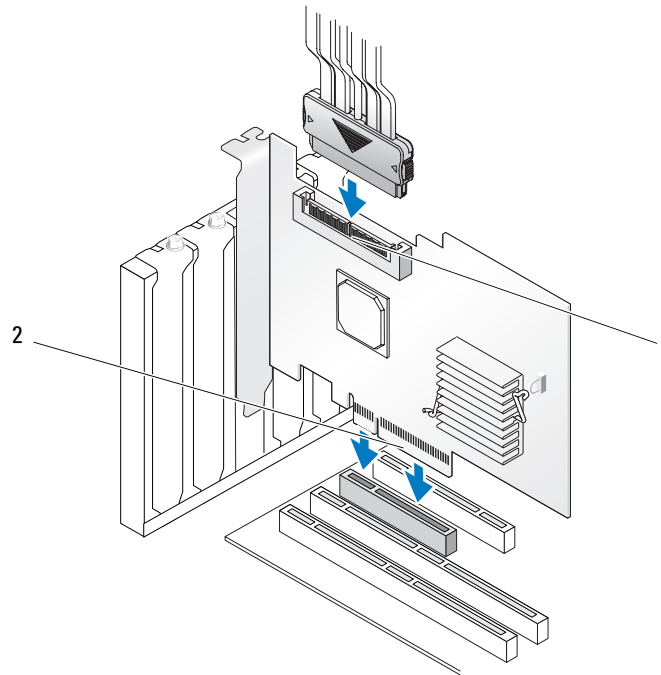

- 1 SAS x4 internal connector 2 PCI-E connector

About RAID

RAID is a group of multiple independent physical disks that provide high performance by increasing the number of drives used for saving and accessing data. A RAID disk subsystem improves I/O performance and data availability. The physical disk group appears to the host system as a single storage unit or as multiple logical units. Data throughput improves because multiple disks can be accessed simultaneously. RAID systems also improve data storage availability and fault tolerance.

RAID Levels

Integrated Striping or RAID 0 uses disk striping to provide high data throughput, especially for large files in an environment that requires no data redundancy.

Integrated Mirroring or RAID 1 uses disk mirroring so that data written to one physical disk is simultaneously written to another physical disk. This is good for small databases or other applications that require small capacity, but complete data redundancy.

➔ **NOTICE:** Lost data on an Integrated Striping virtual disk cannot be recovered in the event of a physical disk failure.

RAID Terminology

Integrated Striping

Integrated Striping (RAID 0) allows you to write data across multiple physical disks instead of just one physical disk. Integrated Striping involves partitioning each physical disk storage space into 64 KB stripes. These stripes are interleaved in a repeated sequential manner. The part of the stripe on a single physical disk is called a stripe element.

For example, in a four-disk system using only Integrated Striping, segment 1 is written to disk 1, segment 2 is written to disk 2, and so on. Integrated Striping enhances performance because multiple physical disks are accessed simultaneously, but Integrated Striping does not provide data redundancy. Figure 1-2 shows an example of Integrated Striping.

Figure 1-2. Example of Integrated Striping (RAID 0)

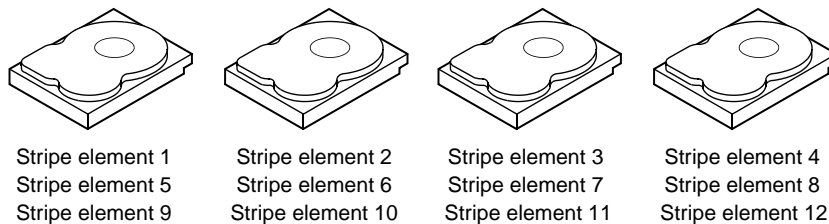

Integrated Mirroring

With Integrated Mirroring (RAID 1), data written to one disk is simultaneously written to another disk. If one disk fails, the contents of the other disk can be used to run the system and rebuild the failed physical disk. The primary advantage of Integrated Mirroring is that it provides 100 percent data redundancy. Because the contents of the disk are completely written to a second disk, it does not matter if one of the disks fails. Both disks contain the same data at all times. Either physical disk can act as the operational physical disk.

 **NOTE:** Mirrored physical disks improve read performance by read load balance.

Figure 1-3. Example of Integrated Mirroring (RAID 1)



SAS 5/iR Features

This section provides the specifications of Dell™ Serial-Attached SCSI (SAS) 5/iR controller. The following table compares the specifications of the SAS 5/iR Adapter and SAS 5/iR Integrated.

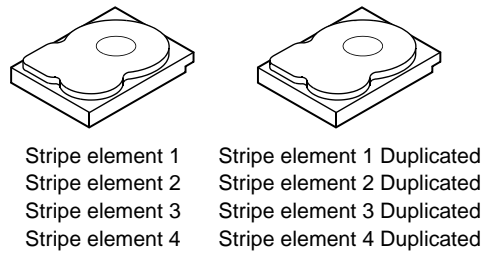
Table 2-1. Specifications of SAS 5/iR

Specification	SAS 5/iR Adapter	SAS 5/iR Integrated
SAS technology	Yes	Yes
Support for x4, x8, or x16 PCI Express Host Interface	Yes	Yes
Form Factor	Standard-Height, Half-Length PCI Adapter	N/A
I/O controller (IOC)	LSI SAS 1068	LSI SAS 1068
	Core Speed: 255 MHz	Core Speed: 255 MHz
Operating voltage requirements	+12V, +3.3V, +3.3Vaux	+12V, +3.3V, +3.3Vaux
Communication to the system	PCI-E lanes	System dependent
Communication to end devices	SAS Links	SAS Links
SAS Connectors	1 x4 Internal	1 x4 Internal
Lead Free	Yes	Yes
Supported operating systems	Microsoft® Windows® 2000 Server and Windows Server® 2003 Family, Windows XP, Windows Vista™, Red Hat® Enterprise Linux Versions 3, 4, and 5, SUSE® Linux Enterprise Server Versions 9 and 10.	Microsoft Windows 2000 Server and Windows Server® 2003 Family, Windows XP, Windows Vista, Red Hat Enterprise Linux Versions 3, 4, and 5, SUSE Linux Enterprise Server Versions 9 and 10.
Windows Miniport Interface	Storport, SCSIport (Windows 2000 and XP 32-bit only)	Storport, SCSIport (Windows 2000 and XP 32-bit only)
Supported drivers for Linux	Yes	Yes
Dell-compliant SAS and SATA compatibility	Yes	Yes
Dell supported direct connected end devices	Dell-compliant physical disks	Dell-compliant physical disks

Table 2-1. Specifications of SAS 5/iR (continued)

Specification	SAS 5/iR Adapter	SAS 5/iR Integrated
Hot add / Hot remove of end devices	Yes	Yes
SMART error support through management applications	Yes	Yes
Hardware-based RAID	RAID 0, RAID 1	RAID 0, RAID 1
Storage management software	OpenManage Storage Services, SAS RAID Storage Manager	OpenManage Storage Services, SAS RAID Storage Manager
Support for internal tape drive	Yes	No

Hardware Installation

This chapter describes how to install the Dell™ Serial-Attached SCSI (SAS) 5/iR Adapter.

 **NOTE:** The SAS 5/iR Integrated is embedded on the system motherboard and does not require any installation. See your system's *Hardware Owner's Manual* or the *User's Guide* for instructions.

Installing the SAS 5/iR Adapter

 **CAUTION:** For some systems, only trained service technicians are authorized to remove the system cover and access any of the components inside the system. Before performing any procedure, see your *Product Information Guide* for complete information about safety precautions, working inside the computer, and protecting against electrostatic discharge.

- 1 Unpack the SAS 5/iR Adapter and check for damage.

 **NOTE:** Contact Dell if the controller is damaged.

- 2 Turn off the system and attached peripherals, and disconnect the system from the electrical outlet. See your system's *Hardware Owner's Manual* or the *User's Guide* for more information on power supplies.
- 3 Disconnect the system from the network and remove the cover of the system. See your system's *Hardware Owner's Manual* or the *User's Guide* for more information on opening the system.
- 4 Select an appropriate PCI-E slot. Remove the blank filler bracket on the back of the system aligned with the PCI-E slot you have selected.
- 5 Align the SAS 5/iR Adapter to the PCI-E slot you have selected.
- 6 Insert the controller gently, but firmly, until the controller is firmly seated in the PCI-E slot. See Figure 3-1.

Figure 3-1. Installing a SAS 5/iR Adapter

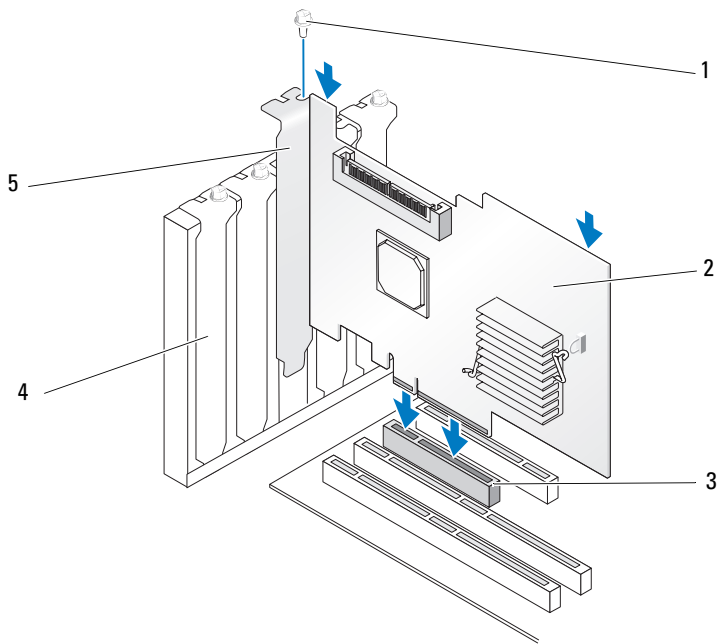

- | | | | | | |
|---|---------------|---|------------------|---|------------|
| 1 | bracket screw | 2 | SAS 5/iR Adapter | 3 | PCI-E slot |
| 4 | PCI bracket | 5 | filler bracket | | |

- 7** Tighten the bracket screw, if any, or use the system's retention clips to secure the controller to the system's chassis.
- 8** Connect the cables from the end devices or the backplane of the system to the controller. See Figure 3-2.

Figure 3-2. Connecting the Cable

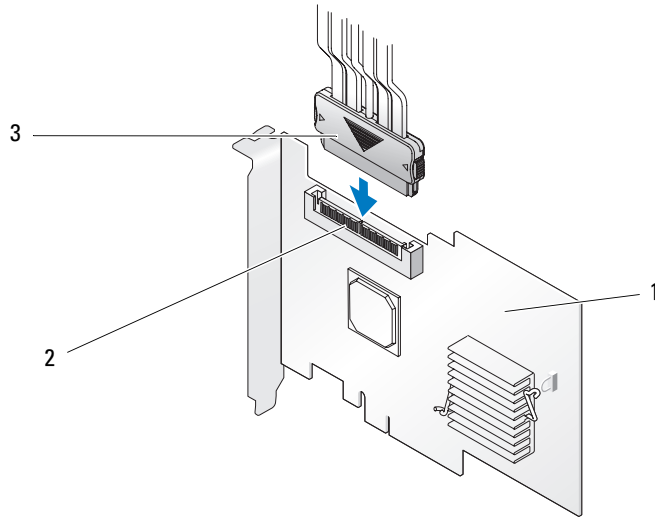

1 SAS 5/iR Adapter 2 SAS x4 internal connector 3 cable

9 Replace the cover of the system. See your system's *Hardware Owner's Manual* or the *User's Guide* for more information on closing the system.

10 Reconnect the power cable(s) and network cables, and then turn on the system.

 **NOTE:** Ensure that you do not connect a hard disk and tape drive to the same SAS 5/iR Adapter.

 **NOTE:** For information on connecting your SAS 5/iR controller to a tape drive see your system's *Hardware Owner's Manual*.

Driver Installation

The Dell™ Serial-Attached SCSI (SAS) 5/iR controller requires software drivers to operate with Microsoft® Windows®, Red Hat® Enterprise Linux, and SUSE® Linux operating systems.

This chapter contains the procedures for installing the drivers for the following operating systems.

- Microsoft Windows 2000 Server family
- Microsoft Windows Server® 2003 Server family
- Microsoft Windows XP
- Red Hat Enterprise Linux Versions 3, 4, and 5
- SUSE Linux Enterprise Server Versions 9 and 10
- Windows Vista™

The four methods for installing a driver that are discussed in this chapter are:

- During operating system installation
- After adding a new SAS 5/iR controller on an existing operating system
- Updating existing drivers
- Installing from a Dell Precision™ workstation *Operating System* CD or DVD. This media includes the drivers

 **NOTE:** Operating system installation on an Integrated Mirroring or Integrated Striping virtual disk is supported only when the virtual disk is in an optimal state.

 **NOTE:** Device drivers are frequently updated. To ensure you have the latest version of any driver mentioned in this section, check the Dell Support website at support.dell.com. If a newer version exists, you can download the driver to your system.

Creating a Driver Diskette

 **NOTE:** Driver diskette is not needed if you are installing from a Dell Precision Workstation *Operating System* CD or DVD.

- 1 Browse to the download section of the system on the Dell Support website at support.dell.com.
- 2 Locate and download the latest SAS 5/iR driver for the system. The drivers are packaged on the Dell Support website such that they can be written onto a diskette.
- 3 Follow the instructions on the support site for extracting the driver to the diskette.

Installing the Driver During Windows Operating System Installation

 **NOTE:** You do not need to install the driver on the Windows Vista™ operating system as the driver is native to this operating system.

Perform the following steps to install the driver during Windows operating system installation.

- 1 Boot the system using the Microsoft® Windows Installation CD.
- 2 When the message **Press F6 if you need to install a third party SCSI or RAID driver** appears, press <F6> immediately.

Within a few minutes, a screen appears that asks for additional controllers in the system.

- 3 Press <S>.

The system prompts for the driver diskette to be inserted.

- 4 Insert the driver diskette in the diskette drive and press <Enter>.

A list of SAS 5/iR drivers appears.

- 5 Select the appropriate driver and press <Enter> to load the driver.

 **NOTE:** For some Windows operating systems, a message may appear that states that the driver you provided is older/newer than the Windows driver. Press <S> to use the driver that is on the floppy diskette.

- 6 Press <Enter> again to continue the installation.

Installing a Windows Driver for a New SAS 5/iR Controller

 **NOTE:** You do not need to install the driver on the Windows Vista operating system as the driver is native to this operating system.

Perform the following steps to configure the driver when you add the SAS 5/iR controller to a system that already has Windows installed.

- 1 Turn off the system.
- 2 Install the new SAS 5/iR controller in the system.
See "Hardware Installation" on page 15 for detailed instructions on installing and cabling the SAS 5/iR controller.

- 3 Turn on the system.

The Windows operating system should detect the new controller and display a message to inform the user.

- 4 The **Found New Hardware** wizard appears and displays the detected hardware device.

 **NOTE:** In some Windows operating systems, the initial **Found New Hardware** screen may request to connect to the internet in order to find the appropriate driver for the found device. Select **No**, not at this time.

- 5 Click **Next**.

- 6 On the **Locate device driver** screen, select **Search for a suitable driver for my device** and click **Next**.
- 7 Provide the appropriate driver package (from your driver diskette) on the **Locate Driver Files** screen.
- 8 Click **Next**.
- 9 The wizard detects and installs the appropriate device drivers for the new SAS 5/iR controller.
- 10 Click **Finish** to complete the installation.
- 11 Restart the system.

Updating an Existing Windows Driver

Perform the following steps to update the Windows driver for the SAS 5/iR controller already installed on your system.

 **NOTE:** It is important that you close all applications on your system before you update the driver.

- 1 Click **Start**→ **Control Panel**→ **System**.

The **System Properties** screen appears.

 **NOTE:** In some Windows operating systems, click **Start**→ **Settings**→ **Control Panel**→ **System**.

- 2 Click on the **Hardware** tab.

- 3 Click **Device Manager**.

The **Device Manager** screen appears.

- 4 Double-click on **SCSI and RAID Controllers**.

- 5 Double-click the SAS 5/iR controller for which you want to update the driver.

- 6 Click the **Driver** tab and click on **Update Driver**.

The **Update Device Driver** wizard appears.

- 7 Insert the appropriate driver diskette.

- 8 Select **Install from a list or specific location**.

- 9 Click **Next**.

- 10 Follow the steps in the wizard to search the diskette for the driver.

- 11 Select the name of the driver file from the diskette.

 **NOTE:** For systems running Windows 2000 operating system, select the appropriate .INF file.

- 12 Click **Next** and continue the installation steps in the wizard.

- 13 Click **Finish** to exit the wizard and restart the system for the changes to take place.

 **NOTE:** Restart is not required for systems installed with Windows Server 2003 x64.

Installing From the Dell Operating System Media

Use the *Operating System* media CD or DVD that came with your Dell Precision workstation to install the driver during the operating system installation.

- 1 Boot to the Dell Precision workstation *Operating System* CD or DVD.
- 2 Continue your operating system installation using the instructions provided in the CD or DVD. The driver loads automatically.

Installing the Red Hat Enterprise Linux Driver

Use the procedures in this section to install the driver for Red Hat Enterprise Linux AS (versions 3, 4, and 5) and ES (versions 3, 4, and 5).

 **NOTE:** The device driver for Red Hat Enterprise Linux AS Version 5 is native. To ensure you have the latest version of this driver, check the Dell Support website at support.dell.com. If a newer version exists, you can download the driver to your system.

Creating a Driver Diskette

Before beginning the installation, copy the drivers from the *Dell™ PowerEdge™ Service and Diagnostic Utilities* CD or download the driver appropriate for Red Hat Enterprise Linux (versions 3, 4, and 5) from the Dell Support website at support.dell.com to your temporary directory. This file includes two Red Hat Package Managers (RPMs) and driver update disk files. The package also contains the Dynamic Kernel Module Support (DKMS) Red Hat Package Manager file.

The package is a gzipped tar file. After downloading the package to a Linux system, perform the following steps.

- 1 `gunzip` the package.
- 2 Execute `tar -xvf` on the package.

 **NOTE:** The package contains DKMS RPM, the driver RPM (DKMS enabled) and the Driver Update Diskette (DUD image(s)).

- 3 Use the `dd` command to create a driver update disk. Use the appropriate DUD image for this purpose.
`"dd if=<name of the dd image file> of=/dev/fd0"`
- 4 Use the diskette for operating system installation as described later in this section.

Creating a Driver Update Diskette

The following files are needed before you create the DUD.



NOTE: The SAS 5/iR driver package installs these files. You do not need to do anything at this point.

- The directory `/usr/src/mptlinux-<driver_version>` contains the driver source code, `dkms.conf`, and specifications file for the driver.
- The subdirectory `redhat_driver_disk` contains the files needed to create the DUD. The files needed are `disk_info`, `modinfo`, `modules.dep`, and `pcitable`.
- To create the DUD image for pre-Red Hat Enterprise Linux (version 4), the kernel source package must be installed to compile the driver. For Red Hat Enterprise Linux 4 distribution, the kernel source is not needed.

Perform the following steps to create the DUD using the DKMS tool:

- 1 Install the DKMS-enabled SAS 5/iR driver rpm package on a system running Red Hat Enterprise Linux operating system.

- 2 Type the following command in any directory:

```
dkms mkdriverdisk -d redhat -m mptlinux -v <driver version>
-k <kernel version>
```

- 3 If you want to build the DUD image for multiple kernel versions, use the following command:

```
dkms mkdriverdisk -d redhat -m mptlinux -v <driver version>
-k <kernel_version_1> -k <kernel_version_2> ...
```

- 4 After the DUD image has been built, you can find it in the DKMS tree for the SAS 5/iR driver.



NOTE: The DKMS package supports both Red Hat Enterprise Linux and SUSE Linux.

Installing the Driver

Perform the following steps to install Red Hat Enterprise Linux (versions 3, 4, and 5) and the appropriate driver.

- 1 Boot normally from the Red Hat Enterprise Linux installation CD.
- 2 At the command prompt, type: `Linux expert dd`
- 3 When the install prompts for a driver diskette, insert the diskette and press `<Enter>`.
See "Creating a Driver Diskette" on page 19 for information on creating a driver diskette.
- 4 Complete the driver installation as directed by the program.

Installing the Driver Using an Update RPM

The following steps explain the installation procedure for the Red Hat Enterprise Linux, AS (versions 3, 4, and 5) operating systems and the appropriate RAID driver using an update RPM.

Installing the RPM Package with DKMS Support

- 1 Uncompress the zipped file of the DKMS-enabled driver package.
- 2 Install the DKMS package using the command: `rpm -Uvh <DKMS package name>`.
- 3 Install the driver package using the command: `rpm -Uvh <Driver package name>`.
- 4 Restart the system to load the new driver.

Installing the SUSE Linux Enterprise Server Driver

Use the procedures in this section to install the driver for SUSE Linux Enterprise Server (versions 9 and 10).



NOTE: The device driver for SUSE Linux Enterprise Server Version 10 is native. To ensure you have the latest version of this driver, check the Dell Support website at support.dell.com. If a newer version exists, you can download the driver to your system.

Installing the Driver Using an Update RPM

The following process explains the installation procedure for the SUSE Linux Enterprise Server (versions 9 and 10) operating system and the appropriate RAID driver using an update RPM.

Installing the RPM Package with DKMS Support

- 1 Uncompress the zipped file of the DKMS-enabled driver package.
- 2 Install the DKMS package using the command: `rpm -Uvh <DKMS package name>`.
- 3 Install the driver package using the command: `rpm -Uvh <Driver package name>`.
- 4 Restart the system to load the new driver.

Creating the Driver Update Diskette

The following files are needed before you create the DUD.



NOTE: The SAS 5/iR driver package installs these files. You do not need to do anything at this point.

- The directory `/usr/src/mptlinux -<driver_version>` contains the driver source code, `dkms.conf`, and specifications file for the driver.
- The subdirectory `redhat_driver_disk` contains the files needed to create the DUD. The files needed are `disk_info`, `modinfo`, `modules.dep`, and `pcitable`.

Perform the following steps to create the DUD using the DKMS tool.

- 1 Install the DKMS-enabled SAS 5/iR driver rpm package on a system running a SUSE Linux operating system.
- 2 Type the following command in any directory:

```
dkms mkdriverdisk -d redhat -m mptlinux -v <driver version>
-k <kernel version>
```

This starts the process to create the SAS 5/iR DUD image.

- 3 If you want to build the DUD image for multiple kernel versions, use the following command:

```
dkms mkdriverdisk -d redhat -m mptlinux -v <driver version>
-k <kernel_version_1> -k <kernel_version_2> ...
```
- 4 After the DUD image has been built, you can find it in the DKMS tree for the SAS 5/iR driver.

 **NOTE:** The DKMS package supports both Red Hat Enterprise Linux and SUSE Linux Enterprise Server.

Installing SUSE Linux Enterprise Server Using the Driver Update Diskette

 **NOTE:** See "Creating a Driver Diskette" on page 19 for information on creating a driver diskette.

- 1 Insert the appropriate SUSE Linux Enterprise Server (versions 9 and 10) Service Pack (SP) CD in the system.
- 2 Select **INSTALLATION** from the menu options.
- 3 Select <F6> for the driver update disk.
- 4 Press <Enter> to load the Linux kernel.
- 5 At the prompt **Please insert the driver update floppy/CDROM**, click **OK**.

The system selects the driver from the diskette and installs it. The system then displays the message **DRIVER UPDATE ADDED** with the description of the driver module.

- 6 Click **OK**.

If you want to install from another driver update medium, continue with the following steps.

- 7 The system displays the message **PLEASE CHOOSE DRIVER UPDATE MEDIUM**.
- 8 Select the appropriate driver update medium if you want to load other drivers.

The system selects the driver from the diskette and installs it.

Upgrading the Kernel

If you run the `up2date` utility to upgrade the kernel, the DKMS enabled driver packages must be reinstalled. To do so, type the following in the same order in a terminal window:

```
dkms build -m <module_name> -v <module version> -k <kernel version>
```

```
dkms install -m <module_name> -v <module version> -k <kernel version>
```

Check whether the driver is successfully installed in the new kernel by typing:

```
dkms status
```

You must see a message similar to the following one on the screen:

```
<driver name>, <driver version>, <new kernel version>: installed
```

SAS 5/iR BIOS

The BIOS of the Dell™ Serial-Attached SCSI (SAS) 5/iR controller (also known as CTRL-C) offers the following features:

- Support for multiple SAS 5 adapters
- POST Memory Management (PMM) support
- RAID configuration tool
- Read-only memory (ROM) BIOS recovery image
- POST status error messaging
- Compatibility with Console Redirection
- POST accessible, text-based configuration utility (CTRL-C)

POST Messages

During POST, the BIOS displays messages that provide the status and identification information of the SAS 5/iR controller, and also displays errors detected during the POST process.

The POST messages display a series of information. The BIOS POST identification banner prints the BIOS identification, copyright information, and the controller version. It displays the list of controllers and devices detected at initialization in a hierarchical order. The BIOS also prompts you to start the Configuration Utility during the POST process.

BIOS Fault Code Messages

When the BIOS encounters errors during initialization, it stops and displays the error warning. By default, the message is followed by a pause and the user is expected to hit any key for acknowledgement. Use the Configuration Utility to disable the pause.

The BIOS offers two options:

- The boot process can be stopped if an error is encountered.
- The boot process can continue even if there is an error.

Configuration Utility

Starting the Configuration Utility

- 1 Boot the system.
- 2 Press <Ctrl+C> during POST when prompted.
If you wait too long and the operating system logo appears, continue to wait until the operating system completes bootup. Then restart your system and try again.

The Configuration Utility menu screen displays.

Functions Performed

 **NOTE:** The screens are organized in a hierarchical fashion and navigation hints are displayed at the bottom of each screen. See the online help for additional information about the utility.

Table 5-1. Functions Performed by the Configuration Utility

Function	Description
Adapter Listing	Lists all the SAS 5/iR controller in the system.
Global Properties	Lists all the configurable global properties of the Configuration Utility and allows setting their values.
Adapter Properties	Lists the properties for the selected SAS 5/iR controller.
SAS Topology	Lists all the SAS 5/iR controllers in the system and the physical interfaces (PHYs) supported by them.
Advanced Adapter Properties	Lists advanced properties of the selected SAS 5/iR controller and allows their modification.
Device Properties	Lists properties of the selected device.
PHY Properties	Lists properties of the selected PHY
Exit/Change Verification	Displays a message indicating the change made or the screen which is being exited and a list of available exit/verification actions.
Select New Virtual Disk Type	Allows you to select the type of virtual disk to create.
Create New Virtual Disk	Allows you to select disks for a new virtual disk.
View Virtual Disk	Allows you to view the current virtual disk configuration.
Manage Virtual Disk	Allows you to manage the current virtual disk.

Navigating the Configuration Utility

The navigation hints are displayed at the bottom of each screen. Online help is also available in the utility. The screens are organized in a hierarchical fashion.

Integrated RAID Configuration and Management Screens

Integrated RAID (IR) configuration and management involves many screens, all of which are accessed by selecting **RAID Properties** on the **Adapter Properties** screen.

- If no RAID virtual disks are currently configured, you are prompted to create a RAID virtual disk.
- If at least one RAID virtual disk is currently configured, select **View Existing Array** to manage the virtual disk(s), or select the appropriate create option to configure a new virtual disk.

The screens in the RAID configuration and management properties area are:

- **Select New Virtual Disk Type**
- **Create New Virtual Disk**
- **View Virtual Disk**
- **Manage Virtual Disk**

Select New Virtual Disk Type

The two options for creating a new virtual disk are **Create IM Volume** and **Create IS Volume**. Additional information about the disk type options appear on the screen.

Create New Virtual Disk

The **Create New Virtual Disk** screen allows you to select disks for a new virtual disk.

- 1 Press <C> to create the virtual disk once the virtual disk is configured.
- 2 Save the changes when prompted to do so.
- 3 Press <F3> to confirm the changes.

After the virtual disk is created, the utility returns to the **Adapter Properties** screen. See the table below for the virtual disk properties description.



NOTE: Dell recommends backing up your data prior to adding or updating configurations.

Table 5-2. Virtual Disk Field Descriptions

Field	Description
Virtual Disk Type	The type of virtual disk being created: IM or IS
Virtual Disk Size	The size of the virtual disk in MB
Slot Num	The slot number the device is located in
Device Identifier	The device identifier

Table 5-2. Virtual Disk Field Descriptions (continued)

Field	Description
RAID Disk	Specifies whether the disk is part of a RAID virtual disk (Yes or No). This field is grayed out under the following conditions: <ul style="list-style-type: none">• The disk does not meet the minimum requirements for use in a RAID virtual disk.• The disk is not large enough to mirror existing data on the primary physical disk.• The disk is a part of another virtual disk.
Pred Fail	Indicates whether device SMART is predicting device failure
Drive Status	The physical disk drive status <ul style="list-style-type: none">• Ok: Disk is online and fully functional• Missing: Disk is not detected• Failed: Disk is not accessible or has reported a failure• Initing: Disk is initializing• Offline: Disk is offline for some other reason• Inactive: Disk has been set inactive• Not Syncd: Data on disk is not synchronized with the rest of the virtual disk• Primary: Disk is the primary disk for a 2-disk mirror and is OK• Secondary: Disk is the secondary disk for a 2-disk mirror and is OK• Wrg Type: Device is not compatible for use as part of the RAID virtual disk• Too Small: Disk is too small to mirror existing data• Max Dks: Maximum # of disks allowed for this type of virtual disk reached• Wrg Intfc: Device interface (SAS/SATA) differs from existing IR disks
Size (MB)	The coerced size of the physical disk in MB (1 MB = (1024 x 1024) = 1,048,576 bytes). NOTE: Disk coercion is used to ensure the disks are the same size. In virtual disks consisting of different sized physical disks, excess space on larger physical disks is unusable.

View Virtual Disk

The **View Virtual Disk** screen allows you to view the current virtual disk configuration.

Press <Alt+N> to view the next virtual disk. See the table above to view descriptions of each virtual disk property.

Manage Virtual Disk

The **Manage Virtual Disk** screen is used to manage the current virtual disk. If you select **Synchronize Mirror**, **Activate Mirror**, or **Delete Virtual Disk**, you are prompted to confirm the choice by pressing **Y** for yes or **N** for no.

Table 5-3. Manage Virtual Disk Field Descriptions

Field	Description
Identifier	The identifier of the virtual disk
Type	The RAID type of the virtual disk
Scan Order	The scan order of the virtual disk
Size (MB)	The size of the virtual disk
Status	The status of the virtual disk
Synchronize Mirror	This option is used to synchronize the IM virtual disk. This option is not accessible under the following conditions: <ul style="list-style-type: none">• The virtual disk is inactive.• The virtual disk does not need to be resynchronized.• IS virtual disk is used.
Manage Secondary Disk	This option is used to add a secondary drive to a degraded IM virtual disk with a missing member. This option is not accessible under the following conditions: <ul style="list-style-type: none">• The virtual disk is inactive.• The virtual disk is not a degraded IM virtual disk with a missing member.• IS virtual disk is used.
Activate Mirror	This option is used to activate an inactive (foreign) virtual disk. The option is grayed out if there are no inactive virtual disks.
Delete Virtual Disk	This option is used to delete the currently displayed virtual disk

Exit Screen

It is important to exit the SAS BIOS Configuration Utility properly, because some changes take effect only when you exit. From the **Adapter List**, press <Esc> to exit. In addition, a similar exit screen appears when you exit most other screens, and it can be used to save settings.

Performing Configuration Tasks

Creating an Integrated Striping Virtual Disk

An Integrated Striping (IS) virtual disk, also referred to as RAID 0, offers the ability to stripe data across multiple physical disks. This can increase storage capacity and performance by combining multiple disks into one logical virtual disk. Follow these steps to create an IS virtual disk on a SAS 5/iR controller that does not currently have a virtual disk configured.

- 1 Select a controller from the **Adapter List** in the Configuration Utility.
- 2 Select the **RAID Properties** option.

- 3 Select **Create IS Volume** when you are prompted to create either an IS virtual disk or an IM virtual disk. The next screen shows a list of disks that can be added to a virtual disk.
- 4 Move the cursor to the **RAID Disk** column. To add a disk to the virtual disk, change “No” to “Yes” by pressing the <+>, <->, or space bar. As disks are added, the **Virtual Disk Size** field changes to reflect the size of the new virtual disk.

 **NOTICE:** All data will be lost upon creation of the virtual disk.

There are several limitations when creating an IS virtual disk:

- All disks must be either Dell-compliant SAS or SATA physical disks.
- SAS and SATA physical disks cannot be used in the same virtual disk.
- Disks must have 512 byte blocks and must not be removable media (e.g., floppy drive, USB key, etc.).
- There must be at least 2 physical disks in a virtual disk.
- No more than 4 physical disks are allowed in a virtual disk.

- 5 Press <C> and then select **Save changes** when the virtual disk has been fully configured.
- 6 Press <F3> to confirm that existing data will be lost with the creation of the virtual disk. The Configuration Utility will pause while the virtual disk is being created.

 **NOTICE:** IS does not provide any data protection in the event of disk failure. It is primarily used to increase performance.

 **NOTE:** Once the number of disks in a RAID virtual disk is set, it cannot be changed.

 **NOTE:** The maximum size of the virtual disk that contains the bootable operating system is 2 Terabytes. This is due to operating system restrictions. The maximum array size (non-bootable) is 16 Terabytes.

Creating a Integrated Mirroring Virtual Disk

An Integrated Mirroring (IM) virtual disk, also referred to as RAID 1, offers the ability to mirror data from one physical disk onto another one. This can increase reliability by combining multiple disks into one logical virtual disk. Follow these steps to create an IM virtual disk on a SAS 5/iR controller that does not currently have a virtual disk configured.

- 1 Select a controller from the **Adapter List** in the Configuration Utility.
- 2 Select the **RAID Properties** option.
- 3 Select **Create IM Volume** when you are prompted to create either an IS virtual disk or an IM virtual disk. The next screen shows a list of disks that can be added to a virtual disk.
- 4 Move the cursor to the **RAID Disk** column. To add a disk to the virtual disk, change “No” to “Yes” by pressing the <+>, <->, or space bar.

 **NOTICE:** Data on both disks will be lost. Dell recommends backing up all data before performing these steps.

5 As disks are added, the Virtual Disk Size field will change to reflect the size of the new virtual disk. There are several limitations when creating an IM virtual disk:

- All disks must be either Dell-compliant SAS or SATA physical disks.
- SAS and SATA physical disks cannot be used in the same virtual disk.
- Disks must have 512-byte blocks and must not have removable media.
- There must be 2 physical disks in an IM virtual disk.

6 Press <C> and then select **Save changes** when the virtual disk has been fully configured.

7 Press <F3> to confirm that existing data will be lost with the creation of the virtual disk. The Configuration Utility will pause while the virtual disk is being created.

 **NOTE:** IM provides protection against the failure of a single physical disk. When a disk fails, the physical disk can be replaced and the data re-mirrored to the physical disk, maintaining data integrity.

 **NOTE:** The maximum size of the virtual disk that contains the bootable operating system is 2 Terabytes. This is due to operating system restrictions. The maximum array size (non-bootable) is 16 Terabytes.

Viewing Virtual Disk Properties

Follow these steps to view the properties of IS and IM virtual disks:

- 1** Select a controller from the **Adapter List** in the Configuration Utility.
- 2** Select the **RAID Properties** option.
 - If there are no existing virtual disks, you will be prompted to create an IM or an IS virtual disk.
 - If there is one existing virtual disk, select **View Existing Array**.
 - If there are two existing virtual disks, press <Alt+N> to view the next virtual disk.
- 3** Press <Enter> when the **Manage Virtual Disk** item is selected to manage the current virtual disk.

Synchronizing a Virtual Disk

Synchronizing a virtual disk means that the firmware synchronizes the data on the secondary disk(s) with the data on the primary disk of the mirror. Follow these steps to start synchronization for an IM virtual disk:

- 1** Select **Synchronize Mirror**.
- 2** Press **Y** to start the synchronization or **N** to cancel it.

Activating a Virtual Disk

A virtual disk can become inactive if, for example, it is removed from one SAS 5/iR controller and moved to another one. The **Activate Mirror** option allows you to reactivate an inactive virtual disk that has been added to a system. This option is only available when the selected virtual disk is currently inactive.

- 1 Select **Activate Mirror**.
- 2 Press **Y** to proceed with the activation or press **N** to abandon it.
After a pause, the virtual disk will become active.

 **NOTE:** Activation of migrated virtual disks is only supported when the migrated virtual disk(s) is in an optimal state and contains all the physical disks.

Deleting a Virtual Disk

 **NOTICE:** Before deleting a virtual disk, be sure to back up all data on the virtual disk that you want to keep.

Follow these steps to delete a selected virtual disk:

- 1 Select **Delete Virtual Disk**.
- 2 Press **Y** to delete the virtual disk or press **N** to abandon the deletion.
- 3 Press **<F3>** to confirm deletion of the virtual disk. After a pause, the firmware deletes the virtual disk.

 **NOTICE:** If the physical disks of a virtual disk are removed and the virtual disk's configuration is subsequently deleted from the SAS 5/iR controller, the physical disks show up only as simple disks with no RAID association if they are placed back onto the same SAS 5/iR controller. Once the virtual disk is removed from a SAS 5/iR controller using the BIOS Configuration Utility (regardless whether the physical disks members are present), the virtual disk cannot be restored.

Replacing and Rebuilding a Degraded Virtual Disk

In the event of a physical disk failure in an IM virtual disk, you will need to replace the disk and resynchronize the virtual disk. Synchronization will occur automatically on replacing the physical disk using the following steps.

- 1 Replace the failed physical disk with a blank disk of the same type and capacity.
- 2 Check your management application or the BIOS Configuration Utility (Ctrl-C) to ensure synchronization started automatically.

 **NOTE:** The Dell SAS 5/iR controller only supports migration of consistent virtual disks and does not support hot migration of virtual disks.

Troubleshooting

To get help with problems with your Dell™ Serial-Attached SCSI (SAS) 5/iR controller, you can Contact Dell or access the Dell Support website at support.dell.com.

BIOS Boot Order

If you intend to boot to the controller, ensure it is set appropriately in the system's BIOS boot order. See your system documentation for more information.

General Problems

Table 6-1. General Problems

Problem	Suggested Solution
The controller displays in Windows® Device Manager but has a yellow bang (exclamation point).	Reinstall the driver. See the driver installation procedures in "Driver Installation" on page 19.
The controller does not appear in Windows Device Manager.	Turn off the system and reseat the controller. Turn on the system.
No Physical Disks Found message appears during a CD installation of Microsoft® Windows 2000 Server, Windows Server® 2003, or Windows XP.	<p>The message appears due to one of the following reasons:</p> <ul style="list-style-type: none"> • The driver is not supported on the operating system. • The controller BIOS is disabled. • Physical disks are not connected or seated properly. <p>The corresponding solutions to the three causes of the message are:</p> <ul style="list-style-type: none"> • Press <F6> to install the Device Driver during installation. • Enter the BIOS Configuration Utility to enable the BIOS. See "SAS 5/iR BIOS" on page 27. • Verify if the physical disks are connected or seated properly.

Physical Disk Related Issues

Table 6-2. Physical Disk Issues

Problem	Suggested Solution
The system does not boot from the SAS 5/iR controller.	Ensure that the boot disk is attached to the controller at the lowest ID and check the controller and the physical disk boot order in the system BIOS. NOTE: See your system documentation for information about boot device selection.
Physical disk is not enumerated during POST.	<ul style="list-style-type: none">• Go to the Configuration Utility and ensure that the physical disk is not enumerated in the SAS topology.• Verify the cable connection.• Reseat the physical disk.• Check and reseat the cable.
One of the physical disks in the array shows the status as "Failed".	<ul style="list-style-type: none">• Check the SAS cables.• Reseat the physical disk.• Check the enclosure or the backplane for damage.• Contact Dell if the problem persists.
Integrated Mirroring (IM) virtual disk does not rebuild.	<ul style="list-style-type: none">• Enter the Configuration Utility and ensure the physical disk is enumerated in the SAS topology.• Ensure the new disk is of the same drive type as the other disk in the virtual disk (SAS/SATA).• Ensure the new disk is of equal or greater capacity as the other disk in the virtual disk.• Ensure the new disk is not detected as an inactive virtual disk under the RAID Properties menu. Delete the newly inserted inactive disk.• Ensure the inserted disk has the same ID as the disk it is replacing. Assign the correct ID to the disk or use the Manage Secondary Disk feature in the Manage Virtual Disk menu.• Ensure the new disk is a Dell supported SAS or SATA disk.

Configuration Utility Error Messages

 **NOTE:** These error messages are displayed inside the Configuration Utility. Restart your system and retry if you encounter any of these.

Table 6-3. Configuration Utility Error Messages

Message	Meaning and Suggested Solution
An error occurred while reading non-volatile settings.	An error reading any one of a number of settings from the firmware. Reseat the controller and reboot.
An error occurred while reading current controller settings.	Controller setup and initialization has failed. Reboot the system.
Advanced Device Properties settings not found.	Failed to read vital configuration page from firmware. Reflash the firmware and reboot.
Advanced Adapter Properties settings not found.	Failed to read vital configuration page from firmware. Reflash the firmware and reboot.
Error obtaining PHY properties configuration information.	Failed to read vital configuration page from firmware. Reflash the firmware and reboot.
Configuration Utility Options Image checksum error.	Failed to properly read Configuration Utility options from flash. Restart and retry. If the issue persists, reflash the firmware on the controller.
Configuration Utility Options Image error.	Failed to properly read Configuration Utility options from flash. Restart and retry. If the issue persists, reflash the firmware on the controller.
Configuration Utility Options Image not found.	Failed to properly read Configuration Utility options from flash. Restart and retry. If the issue persists, reflash the firmware on the controller.
Can't load default Configuration Utility options.	Failed to allocate memory for Configuration Utility options structure.
An error occurred while writing non-volatile settings.	An error occurred while writing one or more settings to the firmware.

BIOS Error Messages

Table 6-4. BIOS Error Messages

Message	Meaning
Press <Ctrl+C> to Enable BIOS	When the BIOS is disabled, you are given the option to enable it by entering the configuration utility. You can change the setting to Enabled in the configuration utility.
Adapter at Baseport xxxx is not responding where xxxx is the baseport of the controller	If the controller does not respond for any reason but is detected by the BIOS, it displays this warning and continues. Shut down the system and try to reset the controller. If this message appears again, Contact Dell.
Following SAS targets are not responding...	When the BIOS determines that previously configured physical disks are not connected to the controller, the BIOS displays this warning and continues to boot. The system continues to boot. See "Physical Disk Related Issues" on page 36 for troubleshooting tips.
Adapter configuration may have changed, reconfiguration is recommended! Press CTRL-C to run Dell SAS 5 Configuration Utility..	Start the Configuration Utility and confirm the configuration of the SAS 5/iR controller.
Initializing...	Displays while the BIOS is waiting to initialize.
SAS discovery error	Indicates that there was a discovery error reported by the firmware and may be accompanied by more such messages. Enter the Configuration Utility to investigate.
Integrated RAID exception detected:	The BIOS detected an exception with one or more RAID virtual disk. For additional troubleshooting information, see the error message "Volume (xx:yy:zzz) is currently in state "STATE".
Volume (xx:yy:zzz) is currently in state "STATE"	Lists the current state of the specified virtual disk when it is not optimal. The state may include: <ul style="list-style-type: none">• INACTIVE: The virtual disk is inactive, possibly foreign, or could be in any one of the states mentioned below.• DEGRADED: The virtual disk is in a degraded state and has lost redundancy.• RESYNCING: The virtual disk is degraded and currently rebuilding.• FAILED: The virtual disk has an error and is in a failed state.• MISSING: The virtual disk is no longer present though a record of it remains.

Table 6-4. BIOS Error Messages (continued)

Message	Meaning
Device not available at	Device may not be ready at this time. The device will be retried. If the problem persists, restart your system.
Spinning up the device!	The device currently being scanned is being spun up.
ERROR! Device is not responding to Read Capacity	The device did not respond to a read capacity command. Contact Dell.
Failed to add device, too many devices!	Could not allocate resources for additional devices.
ERROR! Adapter Malfunctioning!	The adapter did not initialize properly. There may be a problem with the adapter configuration. Reload the BIOS configuration. Invoke the configuration utility again and see if the issue persists.
MPT firmware fault	The LSI Logic MPT firmware faulted. Contact Dell.
Adapter removed from boot order!	An controller that was previously in the boot order was not found. It has either been removed from the system or moved to a different slot.
Updating Adapter List!	A new adapter was found for which there is no record. A record will be created for it.
Adapter(s) disabled by user	An adapter was found, but it has been disabled in the Configuration Utility and will not be used by the BIOS.
Adapter configuration may have changed, reconfiguration is suggested!	A controller has been moved or reinstalled in the system. Add it to the boot order using the available resources.
Memory allocation failed	The controller could not allocate enough memory to load the Configuration Utility, its strings file, or its options file. Reboot the system.
Invalid or corrupt image	One of the images for the Configuration Utility, its strings file, or its options file is corrupt. Reload the BIOS. Reflash the firmware.
Image upload failed	Could not upload the image for the Configuration Utility, its strings file, or its options file. Reload the BIOS. Reflash the firmware.

Table 6-4. BIOS Error Messages (continued)

Message	Meaning
Image not found	Could not locate the image for the Configuration Utility, its strings file, or its options file.
Unable to load LSI Configuration Utility	Could not load the Configuration Utility. This error usually follows one of the four previous messages.
Unable to load LSI Logic Corp MPT BIOS	The controller was downgraded from version 10.x version or greater to 6.x. Contact Dell support for assistance.
MRT BIOS Fault 02h encountered at adapter PCI (XXh, XXh,XXh)	
Fusion-MPT Firmware fault code 0706h	

Updating the Firmware

Firmware updates to the Dell™ Serial-Attached SCSI (SAS) 5/iR controller is achieved by flashing the firmware. The firmware can be flashed while the controller is in use. The system must be restarted for the changes to the firmware to take effect. If there is a failure while flashing the firmware (such as a power outage) the controller reverts back to the earlier version of the firmware.

 **NOTE:** If you flash the firmware while using the controller, you may notice temporary degradation in the controller's performance.

Firmware Update Utility

Firmware update utility can be run from a variety of operating systems. Firmware flash is automated and no user intervention is required. You can obtain firmware flash utility from the *Dell™ PowerEdge™ Service and Diagnostic Utilities* CD.

Running the firmware update utility from the operating system is not supported on Dell Precision workstations. You have to perform a manual update. In the event of new firmware release, check the Dell support site at support.dell.com for the latest firmware updates and the firmware update procedure.

 **NOTICE:** Do not attempt to downgrade the firmware from the 10.x version (or higher) to the 6.x version. This puts the controller in a non-functional state.

Getting Help

Obtaining Assistance

 **CAUTION:** If you need to remove the computer cover, first disconnect the computer power and modem cables from all electrical outlets.

If you need assistance with a technical problem, perform the following steps:

- 1 Complete the procedures in the section "Troubleshooting Your System" of your system's *Hardware Owner's Manual*.
- 2 Run the system diagnostics and record any information provided.
- 3 Use Dell's extensive suite of online services available at Dell Support at support.dell.com for help with installation and troubleshooting procedures.

For more information, see "Online Services" on page 44.

- 4 If the preceding steps have not resolved the problem, call Dell for technical assistance.

 **NOTE:** Call the support service from a phone near or at the system so that the support staff can assist you with any necessary procedures.

 **NOTE:** Dell's Express Service Code system may not be available in all countries.

When prompted by Dell's automated telephone system, enter your Express Service Code to route the call directly to the proper support personnel. If you do not have an Express Service Code, open the Dell Accessories folder, double-click the Express Service Code icon, and follow the directions.

For instructions on using the technical support service, see "Dell Enterprise Training" on page 45 and "Before You Call" on page 46.

 **NOTE:** Some of the following services are not always available in all locations outside the continental U.S. Call your local Dell representative for information on availability.

Technical Support and Customer Service

Dell's support service is available to answer your questions about Dell™ hardware. Our support staff use computer-based diagnostics to provide fast, accurate answers.

To contact Dell's support service, see "Before You Call" on page 46, and then see the contact information for your region or go to support.dell.com.

Online Services

You can access Dell Support at support.dell.com. Select your region on the **WELCOME TO DELL SUPPORT** page, and fill in the requested details to access help tools and information.

You can learn about Dell products and services on the following websites:

www.dell.com

www.dell.com/ap (Asian/Pacific countries only)

www.dell.com/jp (Japan only)

www.euro.dell.com (Europe only)

www.dell.com/la (Latin American and Caribbean countries)

www.dell.ca (Canada only)

You can access Dell Support through the following websites and e-mail addresses:

- Dell Support websites

support.dell.com

support.jp.dell.com (Japan only)

support.euro.dell.com (Europe only)

- Dell Support e-mail addresses

mobile_support@us.dell.com

support@us.dell.com

la-techsupport@dell.com (Latin America and Caribbean countries only)

apsupport@dell.com (Asian/Pacific countries only)

- Dell Marketing and Sales e-mail addresses

apmarketing@dell.com (Asian/Pacific countries only)

sales_canada@dell.com (Canada only)

- Anonymous file transfer protocol (FTP)

ftp.dell.com/

Log in as user: `anonymous`, and use your e-mail address as your password.

Automated Order-Status Service

To check on the status of any Dell products that you have ordered, you can go to support.dell.com, or you can call the automated order-status service. A recording prompts you for the information needed to locate and report on your order. See the contact information for your region.

Dell Enterprise Training

Dell Enterprise training is available; see www.dell.com/training for more information. This service may not be offered in all locations.

Problems With Your Order

If you have a problem with your order, such as missing parts, wrong parts, or incorrect billing, contact Dell for customer assistance. Have your invoice or packing slip available when you call. See the contact information for your region.

Product Information

If you need information about additional products available from Dell, or if you would like to place an order, visit the Dell website at www.dell.com. For the telephone number to call to speak to a sales specialist, see the contact information for your region.

Returning Items for Warranty Repair or Credit

Prepare all items being returned, whether for repair or credit, as follows:

- 1** Call Dell to obtain a Return Material Authorization Number, and write it clearly and prominently on the outside of the box.
For the telephone number to call, see the contact information for your region.
- 2** Include a copy of the invoice and a letter describing the reason for the return.
- 3** Include a copy of any diagnostic information indicating the tests you have run and any error messages reported by the system diagnostics.
- 4** Include any accessories that belong with the item(s) being returned (such as power cables, media such as CDs and diskettes, and guides) if the return is for credit.
- 5** Pack the equipment to be returned in the original (or equivalent) packing materials.

You are responsible for paying shipping expenses. You are also responsible for insuring any product returned, and you assume the risk of loss during shipment to Dell. Collect-on-delivery (C.O.D.) packages are not accepted.

Returns that are missing any of the preceding requirements will be refused at our receiving dock and returned to you.

Before You Call

 **NOTE:** Have your Express Service Code ready when you call. The code helps Dell's automated-support telephone system direct your call more efficiently.

 **NOTE:** See your system's *Hardware Owner's Manual* for the telephone numbers and codes provided to contact Dell Support.

If possible, turn on your system before you call Dell for technical assistance and call from a telephone at or near the system. You may be asked to type some commands at the keyboard, relay detailed information during operations, or try other troubleshooting steps possible only at the system itself. Ensure that the system documentation is available.

 **CAUTION:** Before servicing any components inside your system, see your *Product Information Guide* for important safety information.

Regulatory Notices

Electromagnetic Interference (EMI) is any signal or emission, radiated in free space or conducted along power or signal leads, that endangers the functioning of radio navigation or other safety service or seriously degrades, obstructs, or repeatedly interrupts a licensed radio communications service. Radio communications services include but are not limited to AM/FM commercial broadcast, television, cellular services, radar, air-traffic control, pager, and Personal Communication Services (PCS). These licensed services, along with unintentional radiators such as digital devices, including computer systems, contribute to the electromagnetic environment.

Electromagnetic Compatibility (EMC) is the ability of items of electronic equipment to function properly together in the electronic environment. While this computer system has been designed and determined to be compliant with regulatory agency limits for EMI, there is no guarantee that interference will not occur in a particular installation. If this equipment does cause interference with radio communications services, which can be determined by turning the equipment off and on, you are encouraged to try to correct the interference by one or more of the following measures:

- Reorient the receiving antenna.
- Relocate the computer with respect to the receiver.
- Move the computer away from the receiver.
- Plug the computer into a different outlet so that the computer and the receiver are on different branch circuits.

If necessary, contact Dell™ Support or an experienced radio/television technician for additional suggestions.

Dell™ products are designed, tested, and classified for their intended electromagnetic environment. These electromagnetic environment classifications generally refer to the following harmonized definitions:

- **Class A** is typically for business environments. Class B products may also be utilized in a Class A environment.
- **Class B** is typically for residential environments. Class A products should not be utilized in a Class B environment.

Information Technology Equipment (ITE), including peripherals, expansion cards, printers, input/output (I/O) devices, monitors, and so on, that are integrated into or connected to the system should match the electromagnetic environment classification of the computer system.

A Notice about Shielded Signal Cables: Use only shielded cables for connecting peripherals to any Dell™ device to reduce the possibility of interference with radio communications services. Using shielded cables ensures that you maintain the appropriate EMC classification for the intended environment. For parallel printers, a cable is available from Dell™. If you prefer, you can order a cable from Dell™ on the World Wide Web at www.dell.com.

Dell has determined that this product is a **Class B** harmonized product. The following sections provide country-specific EMC/EMI or product safety information.

FCC Notices (U.S. Only)

FCC, Class B

This equipment generates, uses, and can radiate radio frequency energy and, if not installed and used in accordance with the manufacturer's instruction manual, may cause interference with radio and television reception. This equipment has been tested and found to comply with the limits for a Class B digital device pursuant to Part 15 of the FCC Rules.

This device complies with Part 15 of the FCC Rules. Operation is subject to the following two conditions:

- 1 This device may not cause harmful interference.
- 2 This device must accept any interference received, including interference that may cause undesired operation.



NOTICE: The FCC regulations provide that changes or modifications not expressly approved by Dell™ Inc. could void your authority to operate this equipment.

These limits are designed to provide reasonable protection against harmful interference in a residential installation. However, there is no guarantee that interference will not occur in a particular installation. If this equipment does cause harmful interference with radio or television reception, which can be determined by turning the equipment off and on, you are encouraged to try to correct the interference by one or more of the following measures:

- Reorient the receiving antenna.
- Relocate the system with respect to the receiver.
- Move the system away from the receiver.
- Plug the system into a different outlet so that the system and the receiver are on different branch circuits.

If necessary, consult a representative of Dell™ Inc. or an experienced radio/television technician for additional suggestions.

The following information is provided on the device or devices covered in this document in compliance with FCC regulations:

- Product name: Dell™ SAS 5/iR Adapter
- Company name: Dell™ Inc.
Worldwide Regulatory Compliance & Environmental Affairs
One Dell™ Way
Round Rock, Texas 78682 USA
512-338-4400

Industry Canada (Canada Only)

Industry Canada, Class B

This Class B digital apparatus complies with Canadian NMB-003.



NOTICE: The Industry Canada regulations provide that changes or modifications not expressly approved by Dell™ Inc. could void your authority to operate this equipment.

Industry Canada (Canada uniquement)

Industry Canada, Classe B

Cet appareil numérique de Classe B est conforme à la norme NMB-003 du Canada.



AVIS : La réglementation d'Industry Canada précise que tout changement ou modification non expressément approuvé par Dell peut annuler vos droits d'utilisation de cet équipement.

CE Notice (European Union)

This product has been determined to be in compliance with 73/23/EEC (Low Voltage Directive), 89/336/EEC (EMC Directive), and amendments of the European Union.

European Union, Class B

This Dell™ device is classified for use in a typical Class B domestic environment.

A "Declaration of Conformity" in accordance with the preceding directives and standards has been made and is on file at Dell™ Inc. Products Europe BV, Limerick, Ireland.

Předpisy CE (Evropská unie)

Bylo ověřeno, že tento produkt vyhovuje směnicím 73/23/EEC (nízkonapěťová směrnice), 89/336/EEC (směrnice EMC) a dodatkům Evropské unie.

Evropská unie, třída B

Toto zařízení společnosti Dell je klasifikováno pro použití v obvyklém prostředí domácností (třída B).

Bylo provedeno "Prohlášení o shodě" v souladu s předchozími nařízeními a standardy, které se nachází ve spisech společnosti Dell Inc. Products Europe BV, Limerick, Irsko.

CE-krav (Europæiske Union)

Dette produkt er fundet at være i overensstemmelse med 73/23/EEC (Lavspændingsdirektiv), 89/336/EEC (EMC direktiv) og rettelsler fra den Europæiske Union.

Europæiske Union, Klasse B

Denne Dell-enhed er klassificeret til anvendelse i et typisk Klasse B hjemligt miljø.

En "Overensstemmelseserklæring", som er i henhold til foregående direktiver og standarder, er udført og arkiveret hos Dell Inc. Products Europe BV, Limerick, Irland.

CE-kennisgeving (Europese Unie)

Dit product voldoet aan de eisen van 73/23/EEC (laagspanningsrichtlijn), 89/336/EEC (EMC-richtlijn) en amendementen van de Europese Unie.

Europese Unie, klasse B

Dit Dell-apparaat is geclassificeerd voor gebruik in een typische klasse B woonomgeving.

Er is in overeenstemming met de bovenstaande richtlijnen en normen een "conformiteitsverklaring" opgesteld, welke zich in het archief bevindt bij Dell Inc. Producten Europa BV, Limerick, Ierland.

CE teade (Euroopa Liit)

Käesolev toode vastab määratluse järgi direktiividele 73/23/EMÜ (madalpinge direktiiv), 89/336/EMÜ (elektromagnetilise ühilduvuse direktiiv) ja Euroopa Liidu poolt neis tehtud muudatustele.

Euroopa Liit, klass B

Käesolev Dell'i seade on klassifitseeritud kasutamiseks tavapärasel klassile B vastavas olmekeskkonnas.

Eespool loetletud direktiivide ja standardite kohaselt koostatud vastavusdeklaratsioon asub dokumendina ettevõtte Dell Inc. Products Europe BV kontoril Limerickis Iirimaal.

CE-ilmoitus (Euroopan unioni)

Tämä tuote täyttää direktiivin 73/23/ETY (pienjännittdirektiivi) ja direktiivin 89/336/ETY (sähkömagneettisesta yhteensopivuudesta annettu direktiivi), sellaisina kuin ne ovat muutettuina, vaatimukset.

Euroopan unioni, luokka B

Tämä Dell-laite on luokiteltu käytettäväksi tyypillisessä luokan B asuinympäristössä.

Yllä mainittujen direktiivien ja normien mukainen yhdenmukaisuusilmoitus on tehty, ja sitä säilyttää Dell Inc. Products Europe BV, Limerick, Irlanti.

Réglementation CE (Union européenne)

Ce produit a été déclaré conforme aux directives 73/23/EEC (Directive sur la faible tension), 89/336/EEC (Directive EMC) et aux amendements de l'Union européenne.

Union européenne, classe B

Cet appareil Dell est classé pour une utilisation dans un environnement résidentiel (classe B).

Une «Déclaration de Conformité» relative aux normes et directives précédentes a été rédigée et est enregistrée à Dell Inc. Products Europe BV, Limerick, Irlande.

CE-Hinweis (Europäische Union)

Es ist befunden worden, dass dieses Produkt in Übereinstimmung mit 73/23/EEC (Niederspannungs-Richtlinie), 89/336/EEC (EMC-Richtlinie) und Ergänzungen der Europäischen Union steht.

Europäische Union, Klasse B

Dieses Gerät von Dell ist für die Verwendung in einer typisch häuslichen Umgebung der Klasse B vorgesehen.

Eine Konformitätserklärung in Übereinstimmung mit den oben angeführten Normen ist abgegeben worden und kann bei Dell Inc. Products Europe BV, Limerick, Irland, eingesehen werden.

Σήμα CE (Ευρωπαϊκή Ένωση)

Αυτό το προϊόν έχει κριθεί ότι συμμορφώνεται με την Οδηγία 73/23/ΕΟΚ (χαμηλής τάσης), 89/336/ΕΟΚ (ηλεκτρομαγνητικής συμβατότητας), και τροποποιήσεις τους..

Ευρωπαϊκή Ένωση, Κατηγορία Β

Αυτή η συσκευή Dell είναι κατάλληλη για χρήση σε σύνηθες οικιακό περιβάλλον κατηγορίας Β.

Μία "Δήλωση συμμόρφωσης" σύμφωνα με τις προηγούμενες οδηγίες και πρότυπα υπάρχει και είναι αρχειοθετημένη στην Dell Inc. Products Europe BV, Limerick, Ireland.

CE jelzés (Európai Unió)

A termék megfelel az Európai Unió 73/23/EEC számú, kiszűrtültségű berendezésekre vonatkozó irányelvének, valamint a 89/336/EEC számú EMC irányelvnek és azok módosításainak.

Európai Unió, „B” osztály

Ez a Dell eszköz „B” osztályú besorolást kapott, tipikus lakóhelyi környezetben való használatra alkalmas.

A „Megfelelési nyilatkozat” a fenti direktívákkal és szabványokkal összhangban készült, és a Dell Inc. Products Europe BV cégnél található meg (Limerick, Írország).

Avviso CE (Unione Europea)

Questo prodotto è stato determinato essere conforme alle Direttive 73/23/CEE (Direttiva sulla bassa tensione), 89/336/CEE (Direttiva CEM) ed emendamenti dell'Unione Europea.

Unione Europea, Classe B

Il presente palmare Dell è classificato per l'uso in ambiente residenziale di Classe B.

Una "Dichiarazione di conformità" agli standard e alle direttive precedenti è stata emessa e registrata presso Dell Inc. Products Europe BV, Limerick, Irlanda.

CE paziņojums (Eiropas Savienība)

Ir noteikts, ka šis produkts atbilst Eiropas Savienības 73/23/EEK (direktīvai par zemsprieguma ierīcēm), 89/336/EEK (direktīvai par elektromagnētisko saderību) un to grozījumiem.

Eiropas Savienība, B klase

Šī Dell ierīce tiek klasificēta kā izmantojama ierastos B klases mājas apstākļos.

Saskaņā ar iepriekšminētajām direktīvām un standartiem ir izdota „Atbilstības deklarācija”, kas ir atrodama Dell Inc. Products Europe BV, Limerikā, Īrijā.

CE žyma (Europos Sąjunga)

Nustatyta, kad šis gaminys atitinka direktyvas 73/23/EEC (žemos įtampos direktyva), 89/336/EEC (EMC direktyva) ir Europos Sąjungos oficialiųjų dokumentų pakeitimus.

Europos Sąjunga, B klasė

Šis „Dell“ įrenginys klasifikuotas kaip tinkantis naudoti tipiškoje namų ūkio (B klasės) aplinkoje.

Aukščiau paminėtas direktyvas ir standartus atitinkanti „Atitikties deklaracija“ yra saugoma bendrovės kartotekoje adresu „Dell Inc.“ Products Europe BV, Limerick, Airija.

Avviz CE (Unjoni Ewropea)

Gie stabbilit li dan il-prodott hu konformi ma' 73/23/EEC (Direttiva tal-Vultagg Baxx), 89/336/EEC (Direttiva EMC), u emendi ta' l-Unjoni Ewropea.

Unjoni Ewropea, Klassi B

Dan it-tagħmir Dell hu kklassifikat għall-użu f'ambjent domestiku tipiku ta' Klassi B.

Saret "Dikjarazzjoni ta' Konformità" b'konformità mad-direttivi u ma' l-istandards imsemmijin qabel. Din tinsab iffajljata għand Dell Inc. Products Europe BV, Limerick, Irlanda.

Aviso CE (União Europeia)

Foi determinado que este produto está em conformidade com Directiva 73/23/EEC (referente a equipamentos de baixa tensão), Directiva 89/336/EEC (directiva europeia sobre compatibilidade eletromagnética) e alterações da União Europeia.

União Europeia, Classe B

Este dispositivo Dell está classificado para utilização num ambiente doméstico típico Classe B.

Uma "Declaração de Conformidade" de acordo com as directivas e padrões precedentes foi elaborada e encontra-se arquivada na Dell Inc. Products Europe BV, Limerick, Irlanda.

Wymogi CE (Unia Europejska)

Niniejszy produkt został uznany za zgodny z 73/23/EWG (Dyrektywą niskonapięciową), 89/336/EWG (Dyrektywą w sprawie kompatybilności elektromagnetycznej) oraz zmianami Unii Europejskiej.

Unia Europejska, klasa B

Niniejsze urządzenie firmy Dell zostało zakwalifikowane do klasy B, do użytku w typowych środowiskach domowych.

„Świadectwo zgodności” zostało sporządzone zgodnie z powyższymi dyrektywami oraz normami i znajduje się w aktach firmy Dell Inc. Products Europe BV, Limerick, Irlandia.

CE Poznámka (Európska únia)

Tento výrobok vyhovuje požiadavkám smernice 73/23/EHS (smernica o nízkom napätí), 89/336/EHS (smernica o elektromagnetickej kompatibilitate) a neskorším zmenám a doplnkom Európskej únie.

Európska únia, Trieda B

Toto zariadenie Dell triedy B je určené pre domáce prostredie.

„Vyhlásenie o zhode“ na základe predchádzajúcich noriem a predpisov je k dispozícii u spoločnosti Dell Inc. Products Europe BV, Limerick, Ireland.

Aviso CE (Comunidad Europea)

Este producto se ha fabricado de conformidad con la Directiva para bajo voltaje 73/23/EEC (Low Voltage Directive), la Directiva (EMC) para compatibilidad electromagnética 89/336/EEC (EMC Directive), y las enmiendas de la Unión Europea.

Unión Europea, Clase B

Este dispositivo Dell está clasificado para ser utilizado en un entorno doméstico convencional de Clase B.

Se ha realizado una "Declaración de conformidad" de acuerdo con las directivas y estándares anteriores y está archivada en Dell Inc. Products Europe BV, Limerick, Irlanda.

Obvestilo CE (Evropska unija)

Ta izdelek je skladen z direktivama 73/23/EEC (direktiva o nizki napetosti) in 89/336/EEC (direktiva o elektromagnetni združljivosti) ter dopolnili Evropske unije.

Evropska unija, razred B

Ta Dellova naprava je razvrščena za uporabo v značilnem bivalnem okolju razreda B.

Podana je bila «Izjava o skladnosti», skladna z zgoraj navedenimi direktivami in standardi, ki je na voljo pri Dell Inc. Products Europe BV, Limerick, Irska.

Meddelande om CE-märkning (Europeiska Unionen)

Denna produkt har fastställts att överensstämmer med 73/23/EEC (lägspänningsdirektiv), 89/336/EEC (EMC-direktiv) och ändringar av den europeiska unionen.

Europeiska unionen, klass B

Den här Dell-enheten är klassificerad för användning i vanlig klass B-bostadsmiljö.

En "Försäkran om överensstämmelse" i enlighet med de föregående direktiven och standarderna har framställts och finns registrerad hos Dell Inc. Products Europe BV, Limerick, Irland.

AB Bildirimi (Avrupa Birliđi)

Bu ürünün 73/23/EEC (Düşük Voltaj Direktifi), 89/336/EEC (EMC Direktifi) ve Avrupa Birliđi düzeltmeleriyle uyumlu olduđu belirlenmiştir.

Avrupa Birliđi, B Sınıfı

Bu Dell cihazı tipik B Sınıfı ev alanları kullanımı için sınıflandırılmıştır.

Daha önceki yönetmelik ve standartlara uygun olarak bir "Uygunluk Deklarasyonu" hazırlanmış ve Dell Inc. Products Europe BV, Limerick, İrlanda'da dosyalanmıştır.

CE означение

Този продукт отговаря на 73/23/EEC (Нисковолтова директива), 89/336/EEC (Директива за електромагнитна съвместимост) и измененията на Европейския съюз.

Европейски съюз, Клас В

Това устройство на Dell е класифицирано за използване в типичната за Клас В жилищна среда.

Изготвена е „Декларация за съответствие“ според горепосочените директиви и стандарти, която се съхранява в Dell Inc. Products Europe BV, Лимерик, Ирландия.

Notificare CE

S-a stabilit că acest produs respectă cerințele directivei 73/23/EEC privind joasa tensiune, ale directivei 89/336/EEC privind CEM și amendamentele Uniunii Europene.

Uniunea Europeană, Clasa B

Acest dispozitiv Dell este clasificat pentru utilizare într-un mediu casnic obișnuit de clasă B.

Conform directivelor și standardelor precedente, a fost emisă o Declarație de Conformitate care se află depusă la Dell Inc. Products Europe BV, Limerick, Irlanda.

MIC 규정사항 (한국에 한함)

MIC, B 등급

본 장비는 가정용으로 EMC 등록을 획득했으므로, 주거 지역을 포함한 모든 지역에서 사용할 수 있습니다.



Certification No. : (B)

다음은 MIC 규정 준수에 따라 본 설명서에서 언급하고 있는 등급 B 장치에 관한 것입니다.

- 인증 수취인 : Dell Inc.
Worldwide Regulatory Compliance & Environmental Affairs
One Dell Way
Round Rock, TX 78682 USA
512-338-4400
- 장비 또는 모델명 : 이 정보에 관한 제품 레이블을 참조하십시오.
- 인증 번호 : 이 정보에 관한 제품 레이블을 참조하십시오.
- 제조국가 : 이 정보에 관한 제품 레이블을 참조하십시오.

상기 제품의 제조 날짜는 각 제품에 기재되어 있습니다.

VCCI (日本のみ)

VCCI、クラス B



この装置は、情報処理装置等電波障害自主規制協議会（VCCI）の基準に基づくクラス B 情報技術装置です。この装置は、家庭環境で使用することを目的としていますが、この装置がラジオやテレビジョン受信機に近接して使用されると、受信障害を引き起こすことがあります。

取扱説明書に従って正しい取り扱いをして下さい。

Corporate Contact Details (Taiwan Only)

Pursuant to Article 11 of the Commodity Inspection Act, Dell provides the following corporate contact details for the certified entity in Taiwan for the products addressed by this document:

Dell B.V. Taiwan Branch

20/F, No. 218, Sec. 2, Tung Hwa S. Road,

Taipei, Taiwan

中国大陆 RoHS

根据中国大陆《电子信息产品污染控制管理办法》（也称为中国大陆 RoHS），以下部分列出了 Dell 产品中可能包含的有毒和 / 或有害物质的名称和含量。中国大陆 RoHS 指令包含在中国信息产业部 MCV 标准：“电子信息产品中有毒有害物质的限量要求”中。

Dell 企业产品（服务器、存储设备及网络设备）

部件名称	有毒或有害物质及元素					
	铅 (Pb)	汞 (Hg)	镉 (Cd)	六价铬 (Cr VI)	多溴联苯 (PBB)	多溴联苯醚 (PBDE)
机箱 / 挡板	X	O	X	O	O	O
印刷电路部件 - PCA*	X	O	X	O	O	O
电缆 / 连接器	X	O	X	O	O	O
硬盘驱动器	X	O	X	O	O	O
光盘驱动器 (CD、DVD 等)	X	O	O	O	O	O
磁带 / 介质	X	O	O	O	O	O
软磁盘驱动器	X	O	O	O	O	O
其它 RMSD/ 介质	X	O	O	O	O	O
电源设备 / 电源适配器	X	O	X	O	O	O
电源线	X	O	X	O	O	O
机械部件 - 风扇	X	O	O	O	O	O
机械部件 - 散热器	X	O	O	O	O	O
机械部件 - 电机	X	O	O	O	O	O
机械部件 - 其它	X	O	X	O	O	O
电池	X	O	O	O	O	O
定点设备 (鼠标等)	X	O	O	O	O	O
键盘	X	O	O	O	O	O
快擦写存储器	X	O	O	O	O	O
不间断电源设备	X	O	X	O	O	O
完整机架 / 导轨产品	X	O	X	O	O	O
软件 (CD 等)	O	O	O	O	O	O

* 印刷电路部件包括所有印刷电路板 (PCB) 及其各自的离散组件、IC 及连接器。

“O” 表明该部件所含有害和有毒物质含量低于 MCV 标准定义的阈值。

“X” 表明该部件所含有害和有毒物质含量高于 MCV 标准定义的阈值。对于所有显示 X 的情况，Dell 按照 EU RoHS 采用了容许的豁免指标。

在中国大陆销售的相应电子信息产品（EIP）都必须遵照中国大陆《电子信息产品污染控制标识要求》标准贴上环保使用期限（EPUP）标签。Dell 产品所采用的 EPUP 标签（请参阅实例，徽标内部的编号适用于指定产品）基于中国大陆的《电子信息产品环保使用期限通则》标准。



Glossary

This section defines or identifies technical terms, abbreviations, and acronyms used in this document.

A

Adapter

An adapter enables the computer system to access peripheral devices by converting the protocol of one bus or interface to another. An adapter may also provide specialized function. Adapters may reside on the system board or be an add-in card. Other examples of adapters include network and SCSI adapters.

B

BIOS

(Basic Input/Output System) The part of the operating system in a system that provides the lowest level interface to peripheral devices. BIOS also refers to the Basic Input/Output System of other “intelligent” devices, such as RAID controllers.

BIOS Configuration Utility

The BIOS Configuration Utility configures and maintains user configurable controller parameters. The utility resides in the controller BIOS and its operation is independent of the operating systems on your system. The BIOS Configuration Utility, also known as Ctrl-C, is built on elements called controls. Each control performs a function.

C

Controller

A chip that controls the transfer of data between the microprocessor and memory or between the microprocessor and a peripheral device such as a physical disk or the keyboard. In Storage Management, the hardware or logic that interacts with storage devices to write and retrieve data and perform storage management. RAID controllers perform RAID functions such as striping and mirroring to provide data protection.

D

Disk

A non-volatile, randomly addressable, rewriteable mass storage device, including both rotating magnetic and optical storage devices and solid-state storage devices, or non-volatile electronic storage elements.

DKMS

DKMS stands for Dynamic Kernel Module Support. It is designed to create a framework where kernel dependent module source can reside so that it is very easy to rebuild modules as you upgrade kernels. This will allow Linux vendors to provide driver drops without having to wait for new kernel releases while also taking out the guesswork for customers attempting to recompile modules for new kernels.

Driver

A device driver, often called a driver for short, is a program that allows the operating system or some other program to interface correctly with a peripheral device such as a printer or network PC card. Some device drivers, such as network drivers must be loaded from the config.sys file (with a device= statement) or as memory-resident programs (usually, from the autoexec.bat file). Others such as video drivers must load when you start the program for which they were designed.

DUD (Driver Update Diskette)

Acronym for driver update diskette. A DUD is an image of a diskette stored as a regular file. To use it, you have to create a real diskette from this file. The steps used to create the diskette depend on how the image is supplied.

F

Firmware

Software stored in read-only memory (ROM) or Programmable ROM (PROM). Firmware is often responsible for the behavior of a system when it is first turned on. A typical example would be a monitor program in a system that loads the full operating system from disk or from a network and then passes control to the operating system.

Flash Memory

Sometimes referred as simply "flash", is a compact, solid-state, rewriteable, non-volatile memory device that retains its data when the power is turned off. It offers fast access time, low power consumption, and relative immunity to severe shock or vibration. It is a special type of EEPROM that can be erased and reprogrammed in blocks instead of one byte at a time. Many modern PCs have their BIOS stored on a flash memory chip so that it can easily be updated if necessary. Such a BIOS is sometimes called a flash BIOS.

H

Hardware

The mechanical, magnetic, electronic, and electrical components making up a computer system constitutes its hardware.

Hot Add/Remove

It is the addition/removal of a component while the system is running and operating normally.

L

Link

A connection between any two PCI Express devices is known as a link.

M

MHz

Megahertz or one million cycles per second is a unit of frequency commonly used to measure the operating speed of a computer processor or any other electronic component.

Mirroring

The process of providing complete redundancy using two physical disks, by maintaining an exact copy of one physical disk's data on the second physical disk. If one physical disk fails, the contents of the other physical disk can be used to maintain the integrity of the system and to rebuild the failed physical disk.

O

Operating System

The software that runs a computer, including scheduling tasks, managing storage, and handling communication with peripherals and performs basic input/output functions, such as recognizing input from the keyboard, sending output to the display screen, etc. is called an operating system.

P

PCI Express (PCI-E)

PCI Express (PCI-E) is an evolutionary upgrade to the existing Peripheral Component Interconnect (PCI) bus. PCI-E is a serial connection that operates more like a network than a bus. Instead of one bus that handles data from multiple sources, PCI-E has a switch that controls several point-to-point serial connections. These connections fan out from the switch, leading directly to the devices where the data needs to go. Every device has its own dedicated connection, so devices no longer share bandwidth like they do on a normal bus.

PHY

The interface required to transmit and receive data packets transferred across the serial bus. Each PHY can form one side of the physical link in a connection with a PHY on a different Dell-qualified SATA device. The physical link contains four wires that form two differential signal pairs. One differential pair transmits signals, while the other differential pair receives signals. Both differential pairs operate simultaneously and allow concurrent data transmission in both the receive and the transmit directions.

Physical Disk

A physical disk (also known as hard disk drive) consists of one or more rigid magnetic discs rotating about a central axle, with associated read/write heads and electronics. A physical disk is used to store information, (data), in a non-volatile and randomly accessible memory space.

POST

POST, short for Power-On Self-Test is a process performed before the operating system loads when the computer is turned on. The POST tests various system components, such as RAM, the physical disks, and the keyboard.

R

RAID

Acronym for Redundant Array of Independent Disks (originally Redundant Array of Inexpensive Disks). It is an array of multiple independent physical disks managed together to yield higher reliability and/or performance exceeding that of a single physical disk. The virtual disk appears to the operating system as a single storage unit. I/O is expedited because several disks can be accessed simultaneously. Redundant RAID levels provide data protection.

ROM

Read-only memory (ROM), also known as firmware, is an integrated circuit programmed with specific data when it is manufactured. ROM chips are used not only in computers, but in most other electronic items as well. Data stored in these chips is nonvolatile i.e., it is not lost when the power is turned off. Data stored in these chips is either unchangeable or requires a special operation such as flashing to change.

RPM

RPM, short for "Red Hat Package Manager" is a package management system primarily intended for Linux. RPM installs, updates, uninstalls, verifies and queries software. RPM is the baseline package format of the Linux Standard Base. Originally developed by Red Hat for Red Hat Linux, RPM is now used by many Linux distributions. It has also been ported to some other operating systems such as NetWare by Novell.

S

SAS

Serial-Attached SCSI, SAS, is a serial, point-to-point, enterprise-level device interface that leverages the proven SCSI protocol set. The SAS interface provides improved performance, simplified cabling, smaller connectors, lower pin count, and lower power requirements when compared to parallel SCSI.

SATA

Serial Advanced Technology Attachment, a physical storage interface standard, is a serial link that provides point-to-point connections between devices. The thinner serial cables allow for better airflow within the system and permit smaller chassis designs.

SCSI

SCSI stands for "Small Computer System Interface," a processor-independent standard interface for system-level interfacing between a computer and intelligent devices including hard-drives, floppy disks, CD-ROM, printer, scanners and many more.

SCSIport

SCSIport driver is a Microsoft® driver for Windows® storage architecture, delivering SCSI commands to the storage targets. The SCSIport driver works well with storage using parallel SCSI.

Serial Architecture

Serial architectures have emerged to deliver higher performance by allowing more bandwidth per device pathway than their parallel counterparts. Serial architecture connections consist of a single pair of transmission signals that contain an embedded clock for self-clocking, enabling clock speed to be easily scaled. Serial bus architectures also support a network of dedicated point-to-point device connections, versus the multi-drop architectures of parallel buses, to deliver full bandwidth to each device, eliminate the need for bus arbitration, reduce latency, and greatly simplify hot-plug and hot-swap system implementations.

Serial Technology

Serial storage technology, specifically Serial ATA, Serial-Attached SCSI and PCI Express, address the architectural limitations of their parallel counterparts to deliver highly scalable performance. The technology draws its name from the way it transmits signals - in a single stream, or serially, compared to multiple streams for parallel. The main advantage of serial technology is that while it moves data in a single stream, it wraps data bits into individual packets that are transferred up to 30 times faster than parallel technology data.

SMART

Acronym for Self-Monitoring Analysis and Reporting Technology. The self-monitoring analysis and reporting technology (SMART) feature monitors the internal performance of all motors, heads, and drive electronics to detect predictable drive failures. This feature helps monitor drive performance and reliability, and protects the data on the drive. When problems are detected on a drive, you can replace or repair the drive without losing any data. SMART-compliant disks have attributes for which data (values) can be monitored to identify changes in values and determine whether the values are within threshold limits. Many mechanical failures and some electrical failures display some degradation in performance before failure.

Storport

The Storport driver has been designed to replace SCSIport and work with Windows 2003 and beyond. In addition, it offers better performance for storage controllers, providing higher I/O throughput rates, improved manageability, and an upgraded miniport interface.

Stripe Element

A stripe element is the portion of a stripe that resides on a single physical disk.

Striping

Disk striping writes data across all physical disks in a virtual disk. Each stripe consists of consecutive virtual disk data addresses that are mapped in fixed-size units to each physical disk in the virtual disk using a sequential pattern. For example, if the virtual disk includes five physical disks, the stripe writes data to physical disks one through five without repeating any of the physical disks. The amount of space consumed by a stripe is the same on each physical disk. The portion of a stripe that resides on a physical disk is a stripe element. Striping by itself does not provide data redundancy. Striping in combination with parity does provide data redundancy.

W

Windows

Microsoft Windows is a range of commercial operating environments for computers. It provides a graphical user interface (GUI) to access programs and data on the computer.

X

XP

XP is a Microsoft Windows operating system. Released in 2001, it is built on the Windows 2000 kernel, making it more stable and reliable than previous versions of Windows. It includes an improved user interface and more mobility features, such as plug and play features used to connect to wireless networks.

Index

B

- BIOS, 27
 - Configuration Utility, 28
 - fault code messages, 27
 - POST messages, 27

C

- Configuration Utility
 - functions performed, 28
 - navigating, 28
 - overview, 28
 - starting, 28

D

- drivers
 - creating diskette, 19
 - installation, 19
 - Red Hat Enterprise Linux, 22
 - SUSE Linux Enterprise Server, 24

E

- electrostatic discharge.
 - See* ESD
- ESD, 8

F

- firmware
 - update utility, 41
 - updating, 41

I

- installation
 - driver, 19
 - SAS 5/iR Adapter, 15
 - Windows driver, 20
- Integrated RAID
 - configuration, 29, 31
 - create new virtual disk, 29
 - creating IM, 32
 - creating IS, 31
 - Integrated Mirroring, 11
 - Integrated Striping, 10
 - manage virtual disk, 30
 - new virtual disk, 29
 - rebuilding virtual disk, 34
 - replacing virtual disk, 34
 - view virtual disk, 30
 - virtual disk activation, 34
 - virtual disk deletion, 34
 - virtual disk properties, 33
 - virtual disk
 - synchronization, 33

P

- PCI-E connector, 9

R

- RAID, 9-10
 - RAID 0, 10
 - RAID 1, 10
- Red Hat Enterprise Linux, 19
 - creating a driver diskette, 22
 - installing the driver, 23

S

- safety instructions
 - for preventing ESD, 8
- SAS 5 HBA
 - getting help, 43
- SAS 5/iR
 - BIOS, 27
 - features, 13
 - overview, 9
 - SAS 5/iR Adapter, 9
 - SAS 5/iR Adapter
 - installation, 15
 - SAS 5/iR Integrated, 9
 - specifications, 13
 - troubleshooting, 35
- SCSI
 - controller, 9

T

- troubleshooting, 35
 - BIOS boot order, 35
 - BIOS error messages, 38
 - Configuration Utility error messages, 37
 - physical disk issues, 36

W

- Windows, 19
 - drivers, 19
 - updating drivers, 21